









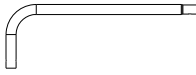
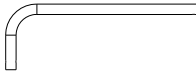
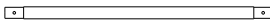
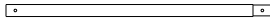
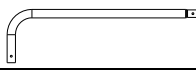

To avoid injury during assembly, disassembly, use, adjustment and/or movement of the PRIMED 2-in-1 Baseball Trainer, the following warnings **MUST** be observed at all time:

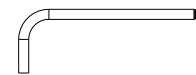
- Two adults should set up the trainer to safely manage net loops that are under tension. Children must never assemble, disassemble, or adjust the trainer.
- When in use, bungee cord net loops will be under extreme tension and must be attached and/or detached according to the instructions. Failure to use this product as intended may result in injury.
- **ALWAYS anchor the trainer.** An unsecured trainer can fall over causing serious injury.
- Never climb on the trainer.

Style Number: PRD00101 PRIMED 2-IN-1 TRAINER

PACKING CONTENTS:

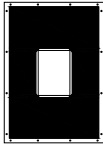
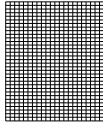
PART NO.	DESCRIPTION	PICTURE	SIZE: 68' ' × 48' '	
			SPEC.	Q' TY
1	L-SHAPED POLE WITH ONE CRIMPED END		28"	3
2	L-SHAPED POLE		28"	3
3	MAIN FRAME SIDE POLE WITH TWO CRIMPED ENDS		28"	2
4	MAIN FRAME SIDE POLE WITH ONE CRIMPED END		28"	2
5	BASE ASSEMBLY L-SHAPED POLE		34"	2
6	ADJUSTABLE SUPPORT POLE		36"	2
7	L-SHAPED POLE WITH ONE CRIMPED END		28"	1
8	L-SHAPED POLE		28"	1
9	NET LOOP		—	44
10	BOLTS AND NUTS		2-1/2"	4
11	BOLTS AND NUTS		2-1/8"	2
12	TARGET RIBBON		—	1
13	GROUND STAKE		—	4
14	TARGET TARP		—	1
15	NET		—	1

ASSEMBLY INSTRUCTIONS

IMPORTANT: DURING ASSEMBLY BE SURE THAT ALL SNAP BUTTONS ARE SECURE AS SEEN IN BELOW FIGURE.



1. CONNECT POLE 1 AND POLE 2 TO FORM A “U” SHAPE FOR ONE TOP AND TWO BOTTOM PARTS OF THE PITCHBACK AS IN BELOW FIGURE .

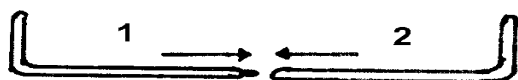

2. CONNECT MAIN FRAME SIDE POLES 3 AND 4 TO FIT TOGETHER AS IN BELOW FIGURE.

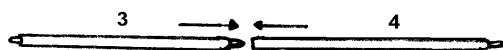

3. TO MAKE THE MAIN FRAME, USE ONE OF THE ASSEMBLED “U” SHAPE POLES (AS STEP1.FIGURE) AND PLACE AN ASSEMBLED MAIN FRAME SIDE POLE (AS ABOVE FIGURE) THEN CONNECT TO FIT TOGETHER AS IN BELOW FIGURE.

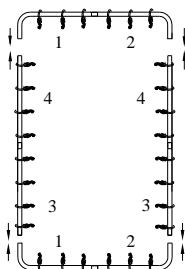

4. PLACE 32 NET LOOPS (PART NO. 9) ONTO THE FRAME. THEN PLACE ANOTHER “U” SHAPED POLE (AS STEP 1. FIGURE) ON THE OPEN END AS IN BELOW FIGURE. REMEMBER TO SPREAD NET LOOPS EVENLY: 10 PIECES ON THE TOP POLE, 6 PIECES ON THE BOTTOM POLE AND 8 PIECES EACH ON BOTH OF THE SIDE POLES.

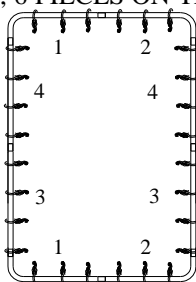

TO MAKE THE BASE ASSEMBLY, USE THE LAST “U” SHAPED ASSEMBLY (AS STEP 1. FIGURE) AND CONNECT WITH BASE ASSEMBLY L-SHAPED POLE 5 ON BOTH SIDES. PLEASE REFER TO FIGURE BELOW. ALSO, SLIDE 4 NET LOOPS ON THE BASE “U” SHAPE FRAME AND 4 STEEL GROUND STAKES (PART NO. 13) ON THE BASE ASSEMBLY POSITIONED AS SHOWN IN BELOW FIGURE.

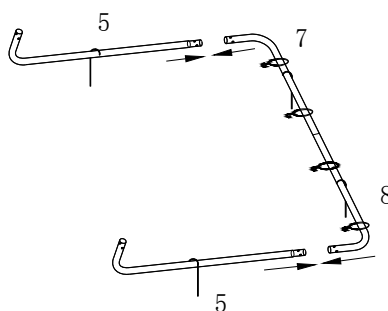

Style Number: PRD00101 PRIMED 2-IN-1 TRAINER

5. TO CONNECT MAIN FRAME TO BASE ASSEMBLY, PLACE THE MAIN FRAME BETWEEN THE OPEN ENDS OF THE BASE ASSEMBLY. MAKE SURE TO LINE UP THE PRE-DRILLED HOLES ON THE FRAME. ATTACH BOLTS AND NUTS (PART NO. 11) ON BOTH SIDES TO SECURE AS IN BELOW FIGURE.

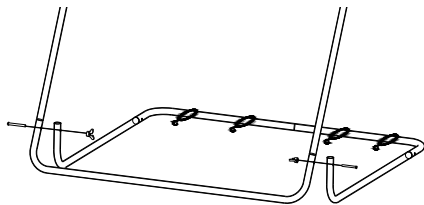

6. ATTACH ADJUSTABLE SUPPORT POLE 6 TO THE OUTSIDE OF THE FRAME USING PART NO. 10 BOLTS AND NUTS AS IN BELOW FIGURE.

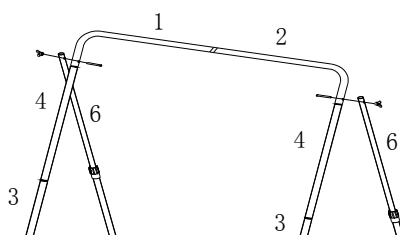

7. PLACE 4 NET LOOPS ON EACH OF THE ADJUSTABLE SUPPORT POLES, PART # 6. JOIN THE BOTTOM PART OF ADJUSTABLE SUPPORTS TO THE LEFT AND RIGHT SIDE OF THE BASE "U" SHAPE POLE (1,2) AT WHERE YOU CAN SEE THE PRE-DRILLED HOLES AND ATTACH BOLTS AND NUTS ON BOTH SIDES TO SECURE AS IN BELOW FIGURE

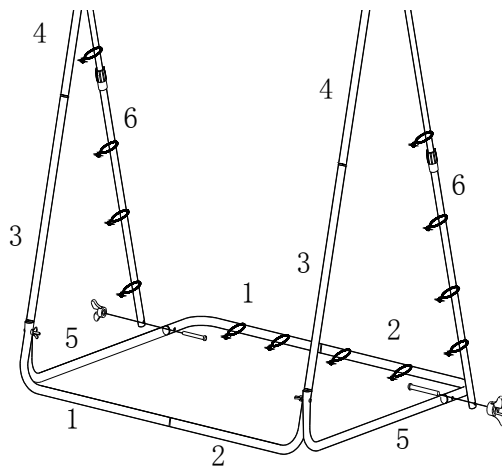

8. SPREAD THE NET ON THE FLOOR AS IN BELOW FIGURE. LOCATE THE RED TABS, WHICH INDICATE THE TOP CORNERS OF THE NET.

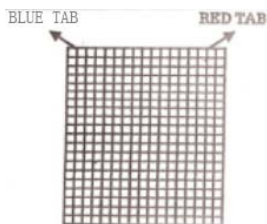

Style Number: PRD00101 PRIMED 2-IN-1 TRAINER

9. SPREAD AND STRETCH THE NET EVENLY AROUND THE FRAME BY USING THE NET LOOPS (PART NO. 9) AS IN BELOW FIGURE. HOOK 6 FROM THE TOP AND BOTTOM U-SHAPED FRAMES, AND 8 FROM EACH OF THE ADJUSTABLE SUPPORTING POLE TO THE NET. **IMPORTANT: DO NOT EXTEND ADJUSTABLE SUPPORT POLE, PART NUMBER 6, BEYOND RED INDICATION MARK.**



10. ATTACH TARGET RIBBON (PART NO.12) BY WEAVING THROUGH NET AND TYING OFF AT ENDS AS IN BELOW FIGURE.



11. SPREAD AND STRETCH THE TARGET TARP EVENLY AROUND THE ADJUSTABLE SUPPORT POLES BY USING THE NET LOOPS (PART NO. 9) AS IN BELOW FIGURE. HOOK 4 NET LOOPS FROM THE TOP AND BASE U-SHAPED FRAMES, AND 4 NET LOOPS FROM EACH OF THE ADJUSTABLE SUPPORTING POLE, PART NUMBER 6, TO THE TARGET TARP.

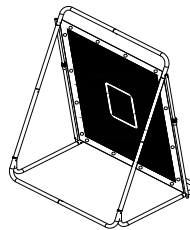

12. POSITION FRAME AS REQUIRED AND FINALLY FIX TO THE GROUND USING THE STEEL GROUND STAKES (PART NO.13) AS IN BELOW FIGURE.

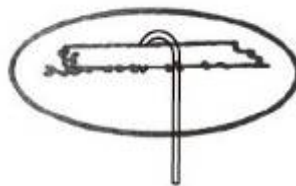

! WARNING

Always anchor the trainer. An unsecured trainer can fall over causing serious injury.



Limited Warranty

Limited Warranty

Dick's Sporting Goods, Inc. (the "Company") warrants this product to be free from defects in workmanship and materials under normal use and conditions for a period of ONE YEAR FROM THE DATE OF ORIGINAL PURCHASE. This Limited Warranty is not transferable and is available only for the original purchaser of the Product. The Company's obligation under this warranty is limited to replacing or repairing the Product, at the discretion of the Company.

EXCEPT AS SPECIFICALLY SET FORTH IN THIS LIMITED WARRANTY, DICK'S SPORTING GOODS, INC. MAKES NO REPRESENTATIONS OR WARRANTIES OF ANY KIND, EXPRESS OR IMPLIED, INCLUDING BUT NOT LIMITED TO ANY IMPLIED WARRANTIES OF MERCHANTABILITY OR FITNESS FOR ANY PARTICULAR PURPOSE WITH RESPECT TO ANY PRODUCT.

Material Covered

Except as detailed below, this Limited Warranty covers defects in materials and workmanship. This Limited Warranty is void if the Product is:

- ° Damaged through improper use, negligence, abuse, misuse, transportation, damage, acts of nature, or accident, to include failure to follow the assembly and or operating instructions supplied with the product.
- ° Used in commercial or rental applications.
- ° Modified or repaired by anyone not authorized by the Company.

Material Not Covered

This Limited Warranty does not cover expendable items including but not limited to: Batteries, light bulbs, fuses, accessories, and other items that experience wear as a result of normal use.

Terms of Coverage

If during the one year LIMITED WARRANTY period, the Company deems any part or component of the Product to be defective, the Company will repair the Product without charge, or at the option of the Company, will replace the Product with new product, either the same or an equivalent item.

The Company's liability is limited to the repair or replacement, at its option of any defective product.

THE COMPANY ASSUMES NO RESPONSIBILITY NOR LIABILITY FOR INDIRECT OR CONSEQUENTIAL DAMAGES OF ANY KIND.

THIS LIMITED WARRANTY IS MADE IN LIEU OF ANY AND ALL OTHER WARRANTIES, EXPRESS OR IMPLIED, EXCEPT AS OTHERWISE PROVIDED BY APPLICABLE LAW.

Please direct all Product inquiries to:

Dick's Sporting Goods, Inc.
345 Court Street
Coraopolis, PA 15108
Customer Service
1 866 677 4771
customer.service@dcs.com